

R&S® SMCV100B

VECTOR SIGNAL GENERATOR

Maximum flexibility in applications
and in production



Product Brochure
Version 02.00

ROHDE & SCHWARZ

Make ideas real



AT A GLANCE

The R&S®SMCV100B vector signal generator is the first multistandard platform for automotive, broadcast, navigation and wireless applications. This makes the R&S®SMCV100B unique for use in many applications, from the lab to production and wherever different technologies meet.

The R&S®SMCV100B vector signal generator features a new direct RF DAC concept for RF signal generation. This concept enables I/Q modulation and upconversion in the digital domain, which eliminates the I and Q imbalance errors and LO leakage associated with traditional analog I/Q modulators.

The R&S®SMCV100B options concept is fully software defined. No hardware options are required to obtain full instrument functionality. This software concept applies to upgrading the RF frequency, memory, I/Q modulation bandwidth and all other R&S®SMCV100B options for other applications.

Thanks to its flexible and customizable design, the instrument is ready to meet future requirements. Options can easily be added via software keycodes, allowing users to quickly upgrade functions and add bandwidth, output power and even frequency range.

The intuitive, touchscreen based operating concept makes the R&S®SMCV100B very ergonomic and practical to use.

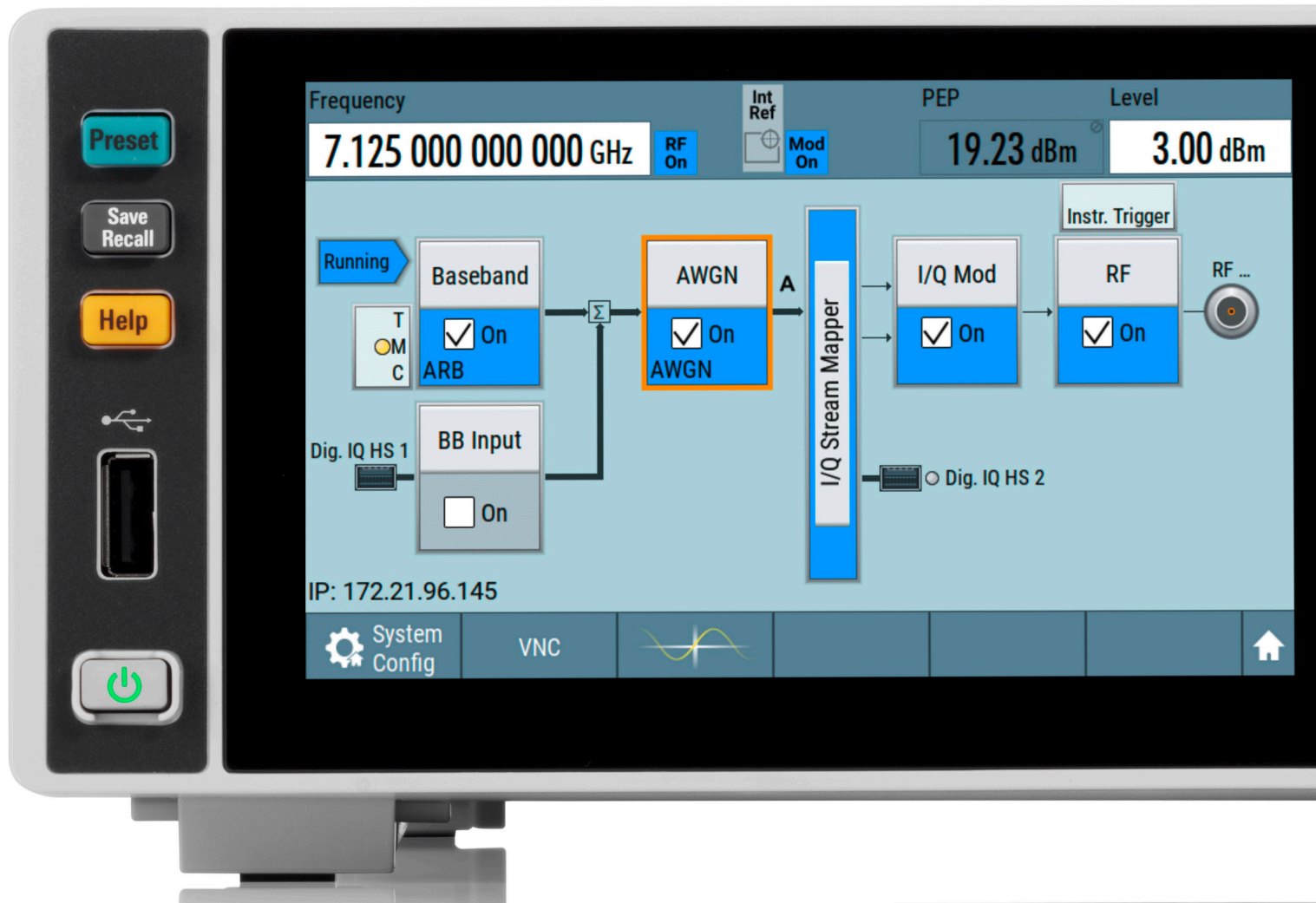

Key facts

- ▶ First multistandard platform for broadcast, navigation, cellular and wireless applications
- ▶ Fully software defined vector signal generator with software based option concept
- ▶ Modern RF signal generation concept with direct digital RF upconversion up to 2.5 GHz
- ▶ High output power up to +25 dBm
- ▶ Modulation bandwidth up to 240 MHz
- ▶ Convenient operation on 5" touchscreen



BENEFITS

First multistandard platform

▶ page 4

User friendly in every detail

▶ page 6

Maximum flexibility in production

▶ page 8

R&S® LegacyPro: refresh your technology

▶ page 9

APPLICATIONS

Functional and end-of-line testing

▶ page 11

Central RF signal generation and cable distribution

▶ page 12

Basic GNSS receiver testing

▶ page 13

Waveform streaming from internal SSD for EMC testing and validation

▶ page 14

OPERATION

State-of-the-art user interface

▶ page 16

Rear panel connections

▶ page 18

FIRST MULTISTANDARD PLATFORM

For automotive, broadcast, navigation and wireless applications

Modern RF signal generation with direct digital RF upconversion concept

The R&S®SMCV100B vector signal generator features a new direct RF DAC concept for RF signal generation. This concept enables I/Q modulation and upconversion in the digital domain which eliminates I and Q imbalance errors and LO leakage as known from traditional analog I/Q modulators.

The direct RF DAC concept is used up to a frequency of 2.5 GHz. For RF frequencies > 2.5 GHz, an analog mixing concept is used to bring the signal to the desired output frequency.

Powerful internal baseband generator

The R&S®SMCV100B provides powerful hardware for internal baseband signal generation. The R&S®SMCV100B either generates signals in real time in FPGAs or it uses the ARB generator to directly generate I/Q signals for digital communications standards. The R&S®WinIQSIM2 signal simulation software can also be used to generate I/Q signals.

Real-time signal generation in FPGAs is especially used for broadcast standards. This technological approach enables continuous and very long uninterrupted signal generation with different data content (audio, video, data, PRBS) for decoding. Such long sequences are required for testing the performance or EMC of tuners.

Measured SSB phase noise for different carrier frequencies

With the R&S®SMCVB-K709 low phase noise option

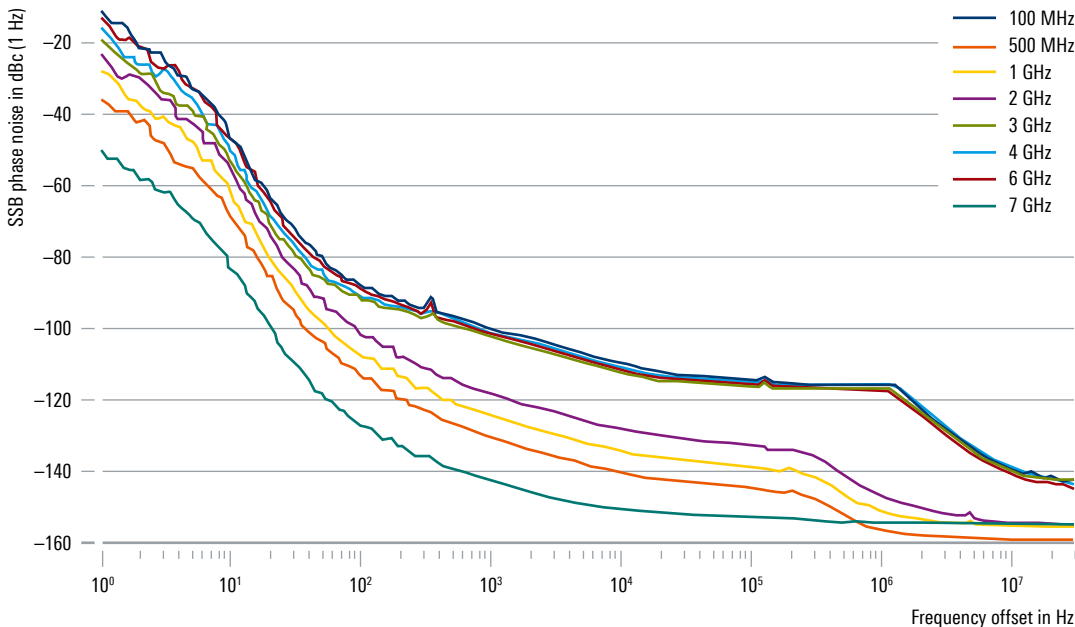

Internal I/Q streaming capabilities

The playing time of arbitrary waveform generators depends on the available hardware memory size and on signal parameters such as the signal bandwidth. This combination usually limits the playing time of conventional ARB generators to a few seconds, which is a problem for measurement applications that require a longer signal duration.

For such applications, the R&S®SMCV100B offers the option of playing back I/Q waveforms from the internal solid state hard disk (64 Gbyte SSD). The maximum RF bandwidth is 56 MHz. A playing time of almost 4 minutes can be achieved with a 60 Gbyte sequence stored on the SSD. For signals with a lower RF bandwidth, the playing time is extended accordingly. A 100 kHz wide FM signal, for example, can be played over a period of several days.

If it is necessary to play even longer I/Q signals, it is possible (via the digital I/Q interface) to use the R&S®SMCV100B in combination with other Rohde&Schwarz instruments such as the R&S®IQW wideband I/Q data recorder.

R&S®WinIQSIM2 waveform generation

Modulated signals for different standards can be generated with the R&S®WinIQSIM2 simulation software. The simulation software supports wireless standards such as 5G and LTE and the generation of noncellular signals such as Wi-Fi® (IEEE 802.11xx) and many others.

Navigation standards for functional Go/NoGo tests

With the R&S®WinIQSIM2 simulation software, the R&S®SMCV100B supports the GPS, GLONASS, Galileo, and BeiDou navigation standards for functional Go/NoGo tests.

Signal content for each navigation standard can be generated with a single navigation satellite. The output of this satellite signal makes it possible to quickly perform a simple functional Go/NoGo test of the navigation receiver. For a functional test with a position fix, predefined waveforms of limited length can be played. This makes the R&S®SMCV100B ideal for production applications.

GNSS signals supported by R&S®WinIQSIM2

Power spectral density of the most important GNSS signals

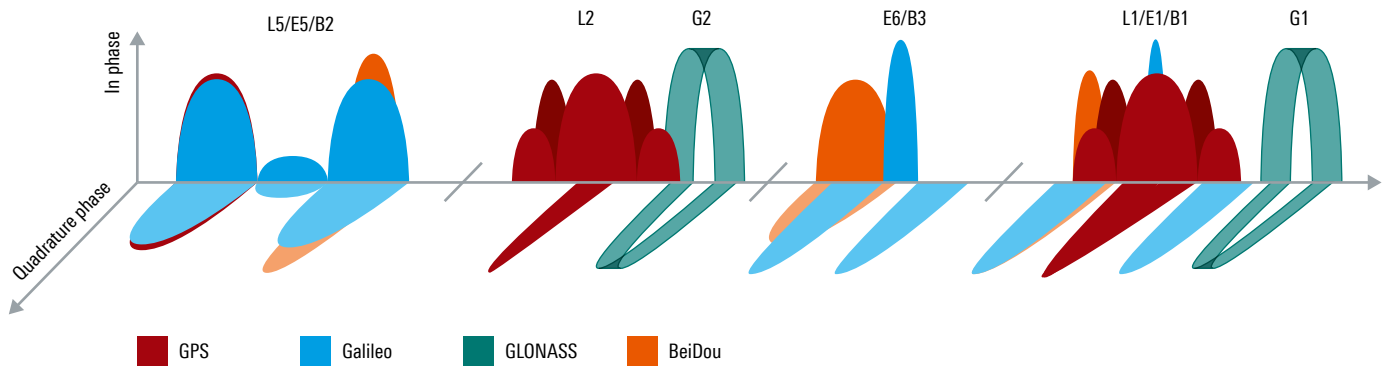

Remark: Galileo E6/B3 on roadmap for future release.

USER FRIENDLY IN EVERY DETAIL

The intuitive operating concept makes the R&S®SMCV100B very ergonomic and practical to use. Thanks to its design for flexible customization, the instrument is ready to fulfill future requirements.

Half a rack size, great performance, smart block diagram operating concept

With its ½ 19" form factor and clearly structured user interface, the R&S®SMCV100B offers optimum operating convenience, a state-of-the-art signal generation concept and great RF performance in a minimum of space. The space saving concept allows installation of a second R&S®SMCV100B or other ½ 19" instrument, such as an R&S®NGM202 power supply, in just one 2 HU mounting frame.

5" touch display in a 2 HU instrument

The high-resolution 5" touch display and clearly structured block diagram user interface enable simple and intuitive operation at all times. The user instantly sees the signal flow in the R&S®SMCV100B as well as the states of the instrument inputs and outputs. An integrated graphic function displays the generated signal in real time.

SCPI macro recorder

The R&S®SMCV100B supports fast and error-free creation of remote control programs. The integrated SCPI macro recorder with its built-in code generator allows users to automatically record all manually performed settings and create a directly executable MATLAB® script.

This minimizes the time and development resources needed to develop test automation.

R&S®HZN96 19" rack adapter with R&S®SMCV100B and R&S®NGM202



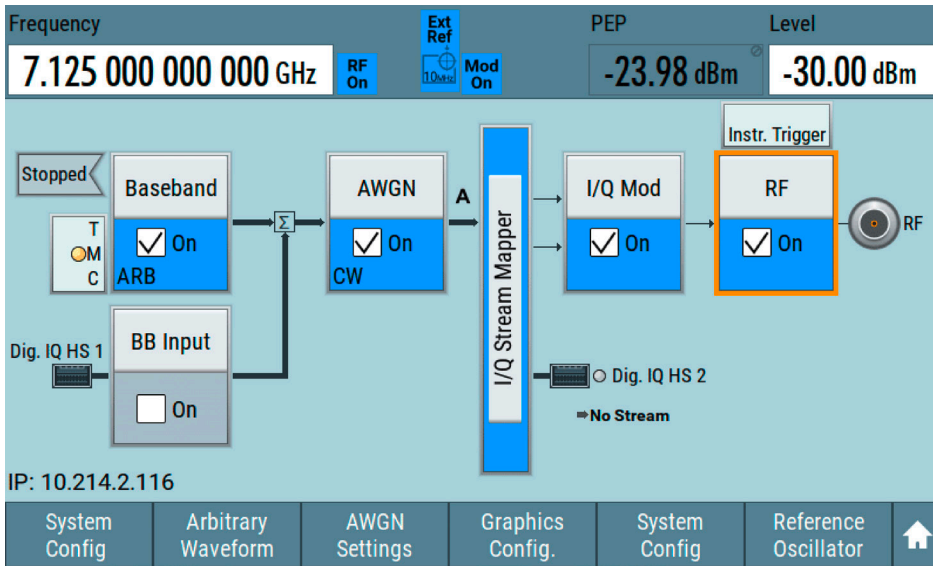

R&S®SMCV100B graphical user interface with block diagram

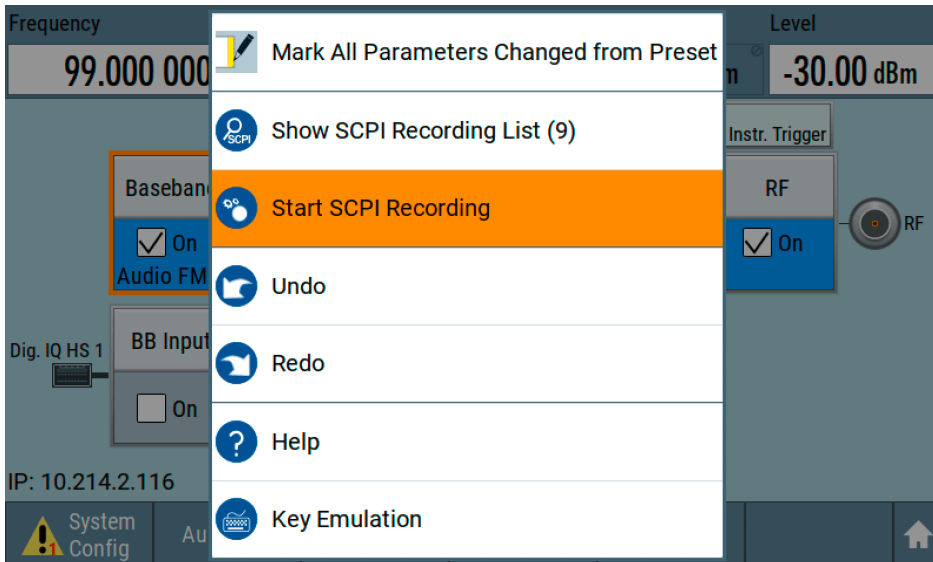

The R&S®SMCV100B generator's built-in SCPI macro recorder and code generator support fast and easy generation of SCPI program sequences

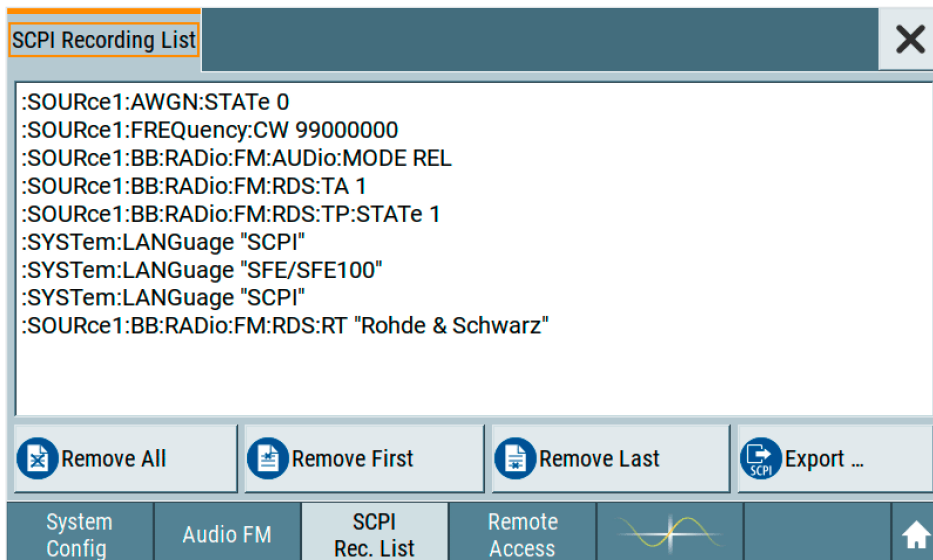

SCPI recording list

MAXIMUM FLEXIBILITY IN PRODUCTION

From functional end-of-line testing to application-specific device software testing

The flexible R&S®SMCV100B easily handles a wide variety of test applications – from a simple functional Go/NoGo test to an end-of-line test on the physical layer or a software test on the application layer with user test data or user-specific data content, such as RDS, TMC and EON data. The various technologies available in the R&S®SMCV100B, such as the arbitrary waveform generator and the real-time encoder for broadcast standards, are used as needed for the specific test scenario.

Fully software defined vector signal generator for easy upgrading at user site

Software options fully cover changing requirements for the signals to be generated. The R&S®SMCV100B can generate signals for virtually all common communications, broadcast and navigation standards as well as user-specific signals. Users simply use keycodes to easily activate all these options on their R&S®SMCV100B.

Standardization of production lines with a single vector signal generator

Thanks to its many frequency ranges, modulation bandwidths, standards and ARB functions, the R&S®SMCV100B is the ideal standard signal generator for production. Software options allow users to adapt the R&S®SMCV100B basic functionality to changing

requirements and products on production lines, making it the right vector signal generator even for EMS contract manufacturers with limited batch sizes. Standardization based on a flexibly configurable vector signal generator offers the additional advantages of less downtime due to failures and servicing on production lines.

Temporary and transferable software licenses

All R&S®SMCV100B software options can also be licensed for a limited time period (e.g. 1 month or 6 months) to accommodate users who do not permanently need certain functions. This allows users to reconfigure the functionality of the R&S®SMCV100B platform as needed on a project-specific basis. It also means the R&S®SMCV100B offers maximum flexibility for production lines.

Minimize the downtime of production lines

The configuration flexibility of the R&S®SMCV100B enables the instrument platform to be used in production lines with different products. The R&S®SMCV100B minimizes downtime on a production line standardized since a replacement R&S®SMCV100B can be quickly configured to provide the necessary functionality. The generator's basic functionality is activated on the replacement generator by using available keycodes or transferable licenses. This capability also minimizes downtime for instrument servicing or calibration.

Space and power saving 19" rack with R&S®SMCV100B in central transmitter room

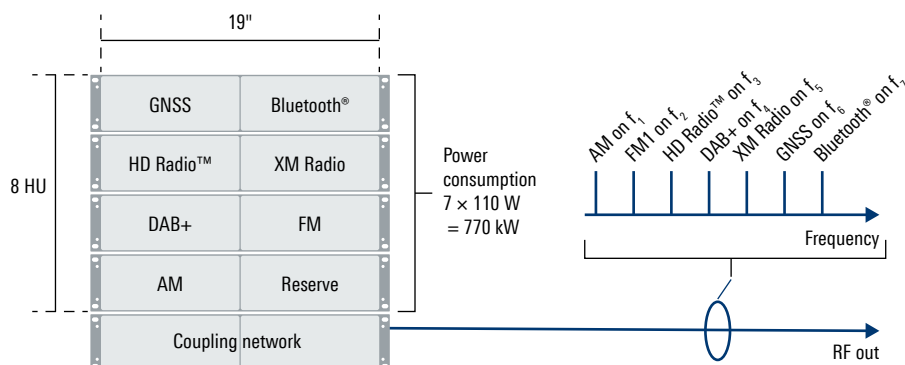

R&S® LegacyPRO: REFRESH YOUR TECHNOLOGY

Enjoy plug and play replacement of your outdated signal generator with the R&S® LegacyPro program and the R&S®SFE100.

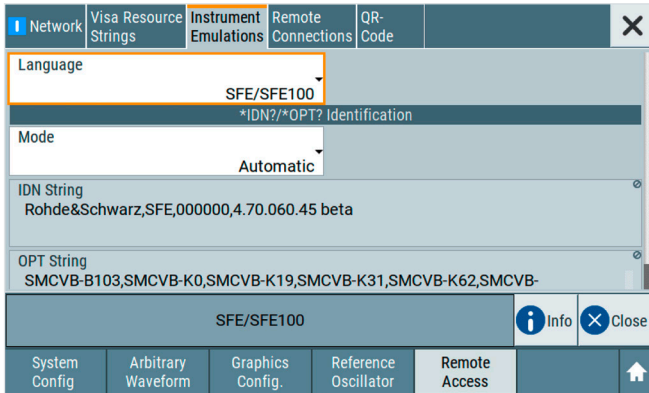

R&S®SMCV100B instrument setup for R&S®SFE100 emulation and replacement

Remote compatibility and emulation of the R&S®SFE100

The challenge associated with existing test systems is servicing the test equipment and eventually replacing it with new, more powerful equipment. The R&S®SMCV100B can be integrated into existing test environments with minimal effort, and the existing remote control and automation software does not have to be changed. Thanks to its R&S®SFE100 emulation mode, the R&S®SMCV100B offers an easy way to replace instruments in existing test systems by simply pulling them out and plugging in a replacement. This solution minimizes the risk and effort involved.



End-of-line test: rack with four operational R&S®SFE100 test transmitters and one spare unit



APPLICATIONS

The many supported standards and its functionality make the R&S®SMCV100B ideal for a large number of applications.

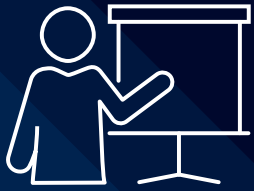

RESEARCH AND EDUCATION

Use in labs at universities, schools, etc.



WIDE BASE MARKET

Use as general purpose instrument in labs



WIRELESS MARKET

Signal generator for producing signals for communications standards such as 5G, LTE, IoT and even Wi-Fi® in line with the different versions of IEEE802.11, Bluetooth® and other standards



BROADCAST CONSUMER EQUIPMENT INDUSTRY

Production and testing of broadcast receivers, set-top boxes, TV receivers, etc.



AUTOMOTIVE INDUSTRY

Production, end-of-line testing of car radios, entertainment and navigation systems and many other products



ELECTRONICS MANUFACTURING SERVICES

Production of different products with constantly varying user requirements regarding modulation types, system bandwidths, etc.



FUNCTIONAL AND END-OF-LINE TESTING

Of infotainment systems and multifunctional antennas

Production requires maximum flexibility and extremely fast response times for generating signals of different standards. With its platform concept, the R&S®SMCV100B precisely meets these requirements and also offers investment protection for future test system expansions. The R&S®SMCV100B is the perfect solution for optimizing existing test systems. The many signal sources previously used for different standards can now be replaced by just one vector signal generator, the R&S®SMCV100B.

The ideal functional and end-of-line tester

- ▶ Space saving single-box solution
- ▶ Simplification and standardization of different test systems based on the R&S®SMCV100B platform
- ▶ Sequential generation of the different signals required
- ▶ Functional tests with audio and video content
- ▶ Software activation of new functions and configuration modifications

Examples for testing DUTs in line with used standards and regional requirements

	EU	USA/Canada	Asia
Audio broadcast	AM/FM RDS	AM/FM RDBS	AM/FM RDS DARC
	DAB/DAB+	HD Radio	T-DMB
		XM Radio	ISDB-Tsb
Navigation	GPS	GPS	GPS
	GLONASS		GLONASS
	Galileo		
Noncellular	Bluetooth®	Bluetooth®	Bluetooth®
	IEEE802.11xx	IEEE 802.11xx	IEEE802.11xx

The Bluetooth® word mark and logos are registered trademarks owned by Bluetooth SIG, Inc. and any use of such marks by Rohde & Schwarz is under license. Wi-Fi® is a registered trademark of Wi-Fi Alliance®.

CENTRAL RF SIGNAL GENERATION AND CABLE DISTRIBUTION

Due to the high RF output power, the signals generated by the R&S®SMCV100B can also be fed into cable distribution networks.

In this scenario, several R&S®SMCV100B instruments generate the same or different signals at different frequencies. The R&S®SMCV100B signal generators are typically all located in one room, the central transmitter room.

From this room, the R&S®SMCV100B signal generators feed the generated RF signals at different frequencies into a common distribution network. The signals are combined in a single cable and can be distributed to several production lines and test stations.

The receiver under test receives all signals fed into the cable at its RF input and can perform the test with the intended signal by simply switching to the respective receiving frequency.

The permanently available signal at each test station is a distinct advantage since the individual production lines do not have to be synchronized and production is therefore not subject to time dependencies.

Central transmitter room application with R&S®SMCV100B and manufacturing line distribution

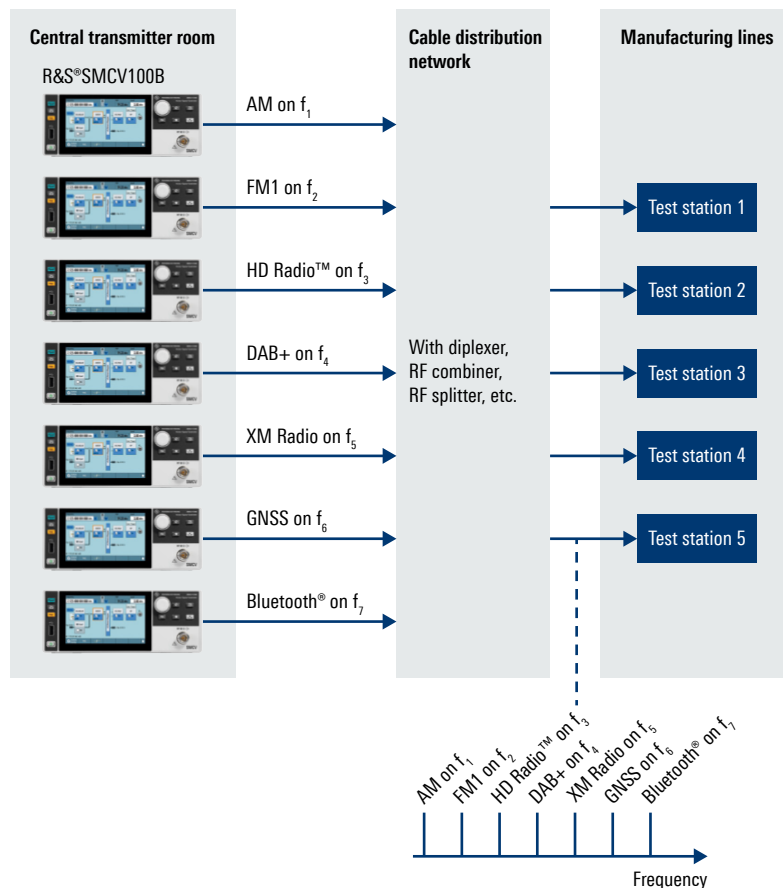

BASIC GNSS RECEIVER TESTING

The R&S®SMCV100B GNSS solutions cover all production testing requirements for GNSS receivers.

Using GNSS waveforms for basic receiver tests

Many Rohde&Schwarz signal generators can be used to play back GNSS waveforms. This approach is ideal for setting up a basic and cost-efficient single-channel test environment for GNSS receiver manufacturing and for performing basic sensitivity tests. GNSS waveforms can be created using the R&S®WinIQSIM2 simulation software and are also available for the R&S®SMCV100B.

GNSS production tester

The R&S®SMCV100B GNSS simulation capabilities address specific needs for GNSS chipset testing and speed-optimized production testing of GNSS receivers. During such tests, the basic GNSS signal reception and the connection between the antenna and GNSS chipset need to be verified. Two types of tests are typically used for this purpose.

Go/NoGo tests on the physical layer

The GNSS receiver is stimulated with a navigation standard signal. Since the simulated signal represents just one satellite in the navigation standard, the receiver cannot carry out positioning. This is a pure Go/NoGo test that can be used to test different aspects of the overall system, for instance the cabling between the GNSS receiving antenna and the navigation receiver.

The R&S®WinIQSIM2 simulation software is used for this simple test. It generates a single GPS, GLONASS, BeiDou or Galileo satellite signal. The base configuration of a 3 GHz R&S®SMCV100B with 64 Msample ARB is sufficient for this test.

Functional tests with positioning fix

The GNSS receiver needs simulated signals from at least four navigation satellites in order to fix a position based on the information transmitted in the signals. The GNSS receiver has to be synchronized with the signals before it can process the position data and fix the position. The different GNSS standards require different waveform lengths to perform a position fix. The R&S®SMCV100B with the R&S®SMCVB-K511 option with 512 Msample can handle such position-fix sequences for each of these standards.

For long position-fix sequences, the R&S®SMCV100B is used with the R&S®SMCVB-K505 waveform streaming option together with predefined waveforms. Each waveform contains a defined navigation scenario with a fixed, unchangeable position. Proprietary I/Q sequences can still be used and played out. The I/Q sequences played out with the waveform streaming option are modulated and transmitted on the selected navigation standard's frequency.

EXAMPLES OF ARB MEMORY DEPTHS NEEDED FOR GNSS WAVEFORMS

Galileo E1 has the largest memory requirements with about 25 Msample for a playing time of one second and an oversampling factor of two. A 64 Msample ARB would result in a maximum playing time of 2.5 seconds.

GPS L1 has a much simpler signal structure and only needs a 2 Msample memory depth for a playing time of one second. A 64 Msample ARB can broadcast a GPS L1-signal for 32 seconds without interruption. This R&S®SMCV100B configuration is ideal for functional tests such as signal tracking and sensitivity tests that only need short playing times.

WAVEFORM STREAMING FROM INTERNAL SSD FOR EMC TESTING AND VALIDATION

With its waveform streaming functionality, the R&S®SMCV100B also supports users working with EMC test applications.

When performing EMC measurements on receivers, it is essential to feed an uninterrupted wanted signal to the DUT to detect possible effects of an interferer. Unlike the real-time coder approach, which can generate an uninterruptible signal, ARB generator approaches are mostly based on a limited memory from which the signals are output.

Depending on the signal properties, an uninterrupted signal can usually only be provided for a short playing time.

The R&S®SMCV100B waveform streaming functionality can stream long I/Q waveform sequences from the internal SSD, from an external hard disk via the USB 3.0 interface or from an I/Q playback device (e.g. an R&S®IQW) via the digital I/Q interface. The stream is output at the R&S®SMCV100B RF output.

Use of the Linux operating system means there are no restrictions on the maximum manageable file size in the R&S®SMCV100B. The USB 3.0 interface supports playback from external storage media.

The R&S®SMCV100B can be used to generate both the wanted signal and the interferer.

Waveform streaming via digital I/Q interface on an XM radio frequency

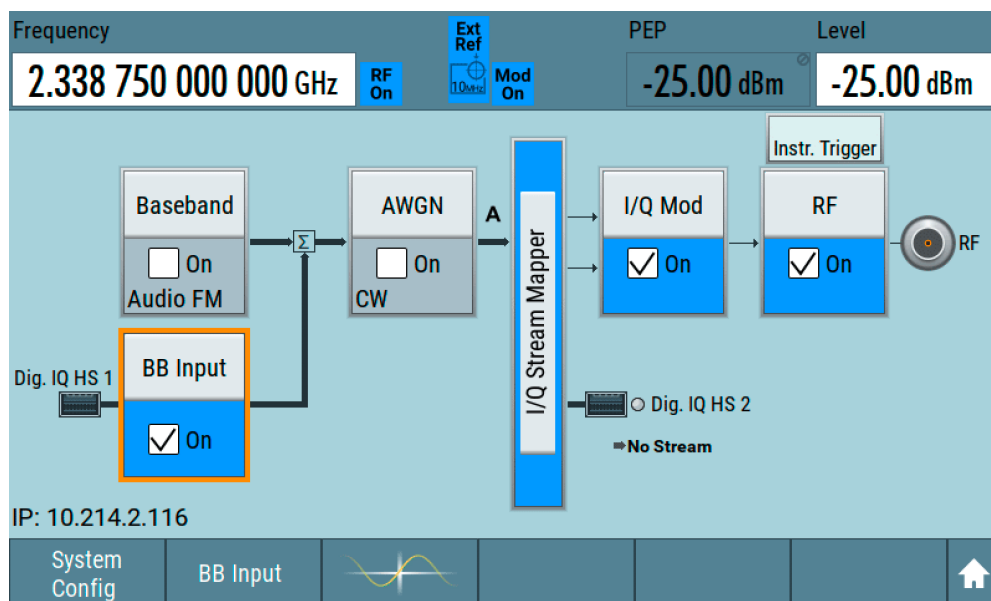

Receiver blocking test scenario using the R&S®SMCV100B to generate wanted signals and interferers

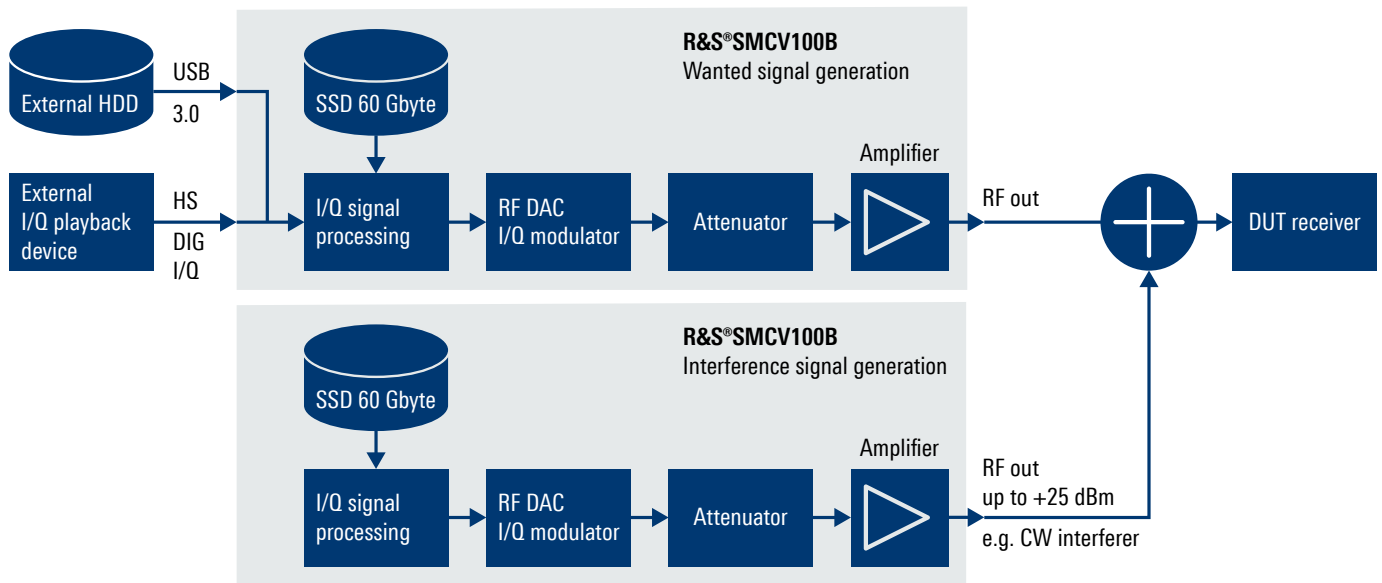

Calculation examples for I/Q waveform streaming with the R&S®SMCV100B

Playback time of internal SSD and external storage medium

Waveform streaming source	I/Q signal bandwidth	Streaming duration
Internal SSD (60 Gbyte)	56 MHz (70 Msymbol/s)	approx. 3.83 min
	100 kHz (125 ksymbol/s)	approx. 35.8 h
External memory device (example 1 Tbyte)	56 MHz (70 Msymbol/s)	approx. 1.09 h
	100 kHz (125 ksymbol/s)	approx. 25.5 days

Waveform streaming via USB 3.0 interface from external memory device

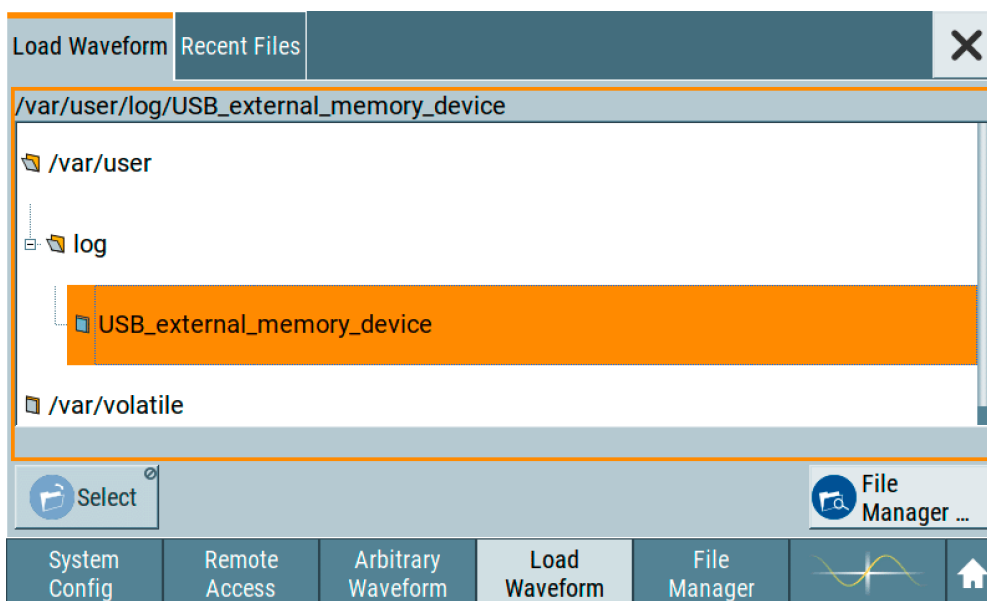

STATE-OF-THE-ART USER INTERFACE

High-resolution touchscreen

With easy-to-use graphical user interface and block diagram concept

Context-sensitive help

With complete user documentation

Quick access

Softkey access to user menus





Favorite key

For simplified and fast operation via customizable user menu

Quick access

With RF on/off hardkey

RF out connector (N female)

With 2 W reverse power protection

Graphical signal monitoring

At practically every point in the signal flow

REAR PANEL CONNECTIONS

DisplayPort

External monitor interface

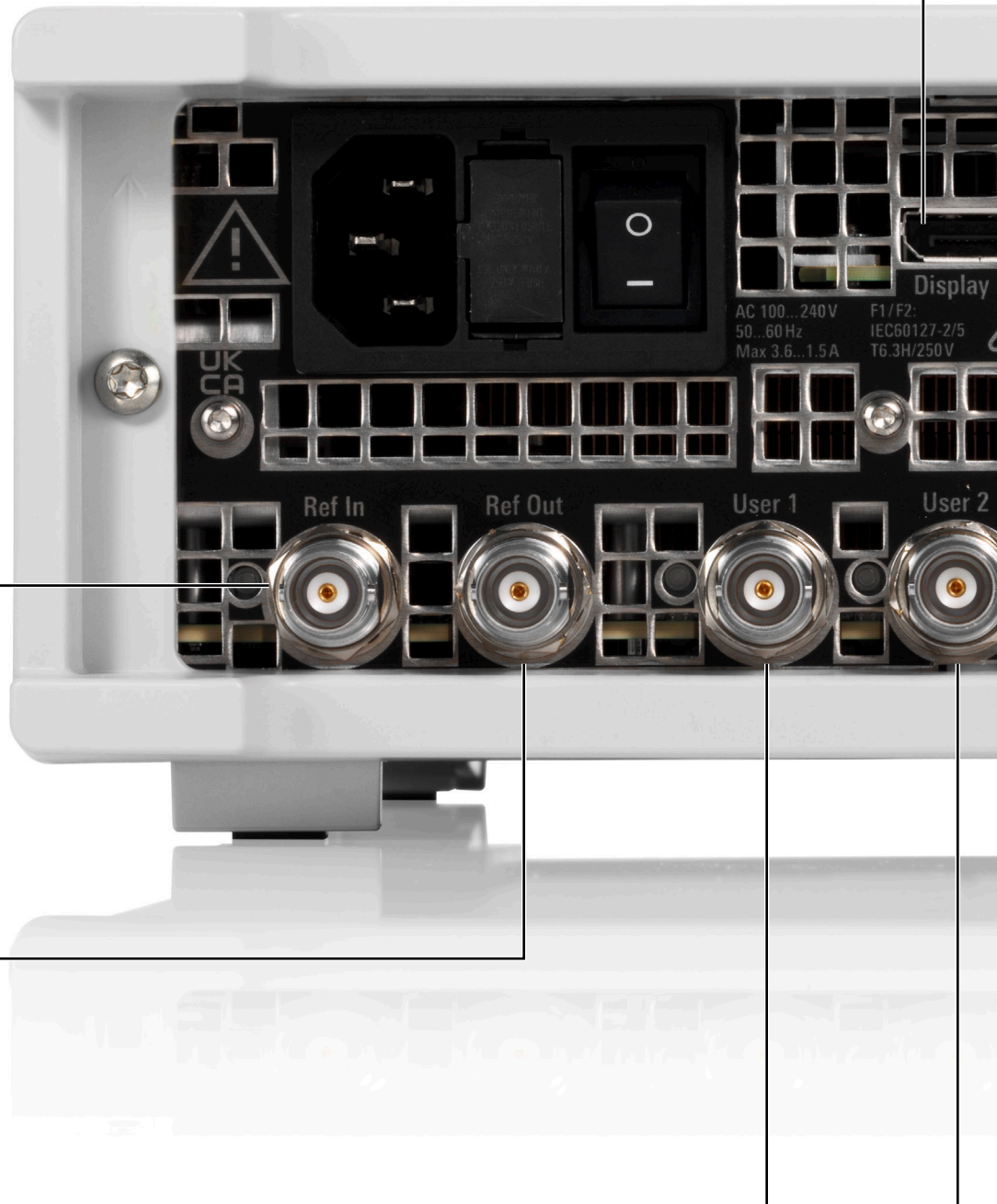

Reference input

For external clock source

Reference output

For synchronizing external instruments

Multifunctional interface

- ▶ Input for ASI, ETI, TS, trigger, SPDIF
- ▶ Output for markers

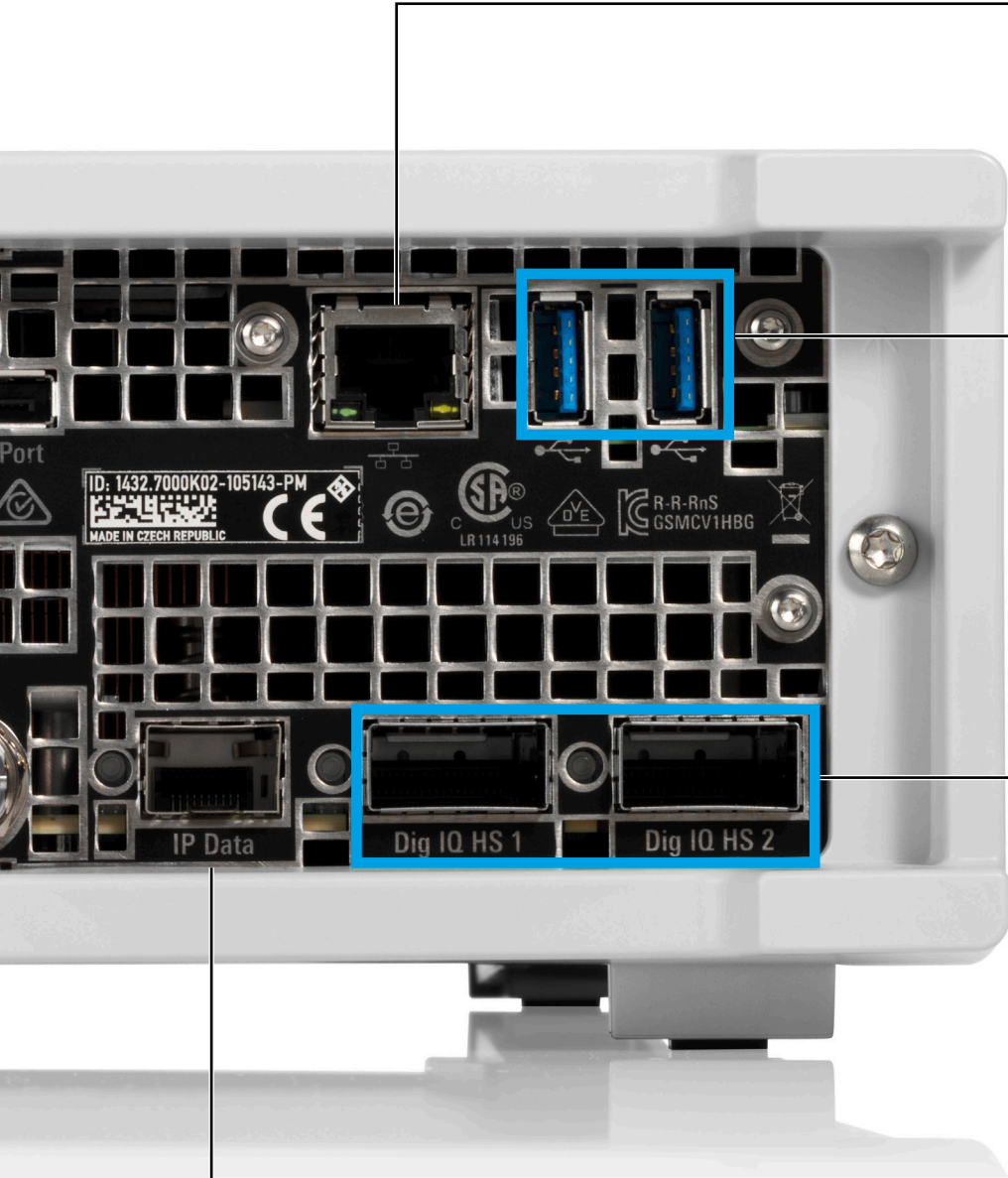

Ethernet (LAN)

For remote access and remote control

USB 3.0 interfaces

PC data and streaming interfaces for waveform streaming

QSFP+ slots with 10BASE-T

For electrical interfaces (prepared for optical interfaces)

IP streaming interface

For external IP streaming to broadcast real-time coders

Multifunctional interface

- ▶ Input for 1 PPS
- ▶ Output for markers

FROM PRESALES TO SERVICE. AT YOUR DOORSTEP.

The Rohde & Schwarz network in over 70 countries ensures optimum on-site support by highly qualified experts.

User risks are reduced to a minimum at all project stages:

- ▶ Solution finding/purchase
- ▶ Technical startup/application development/integration
- ▶ Training
- ▶ Operation/calibration/repair

